

**ИНСТРУКЦИЯ ПО СБОРКЕ ДЛЯ НАБОРА WEDO
2.0**

«ЗАКОН ТЕНСЕГРИТИ»

WEDO 2.0 «ЗАКОН ТЕНСЕРИТИ»



WEDO 2.0 «ЗАКОН ТЕНСЕГРИТИ»

1

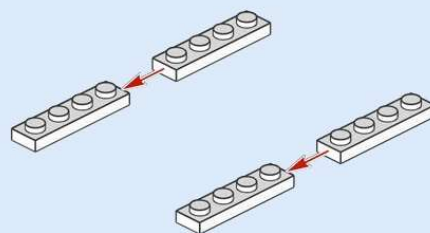
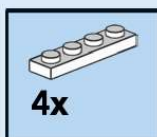

WEDO 2.0 «ЗАКОН ТЕНСЕГРИТИ»

2

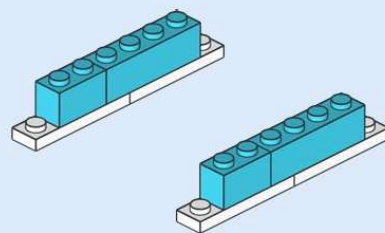
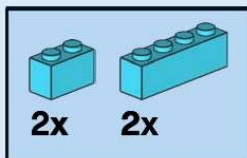

WEDO 2.0 «ЗАКОН ТЕНСЕГРИТИ»

3

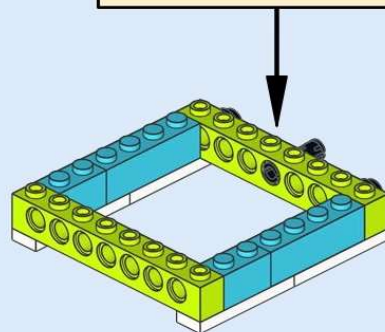
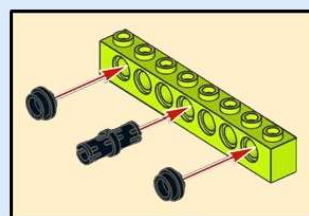
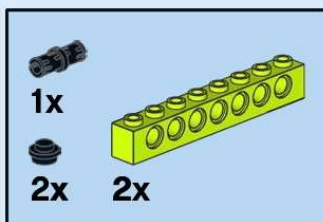

WEDO 2.0 «ЗАКОН ТЕНСЕГРИТИ»

4

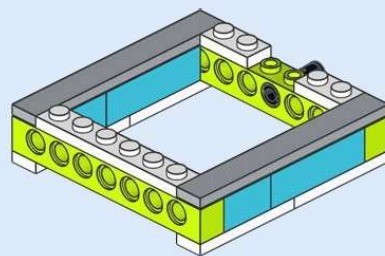
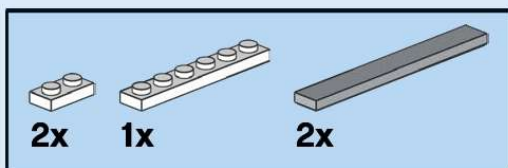

WEDO 2.0 «ЗАКОН ТЕНСЕГРИТИ»

5

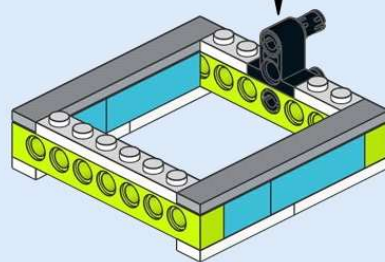
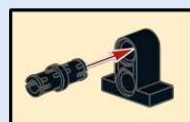
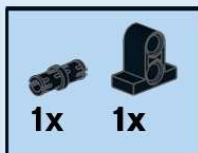

WEDO 2.0 «ЗАКОН ТЕНСЕГРИТИ»

6

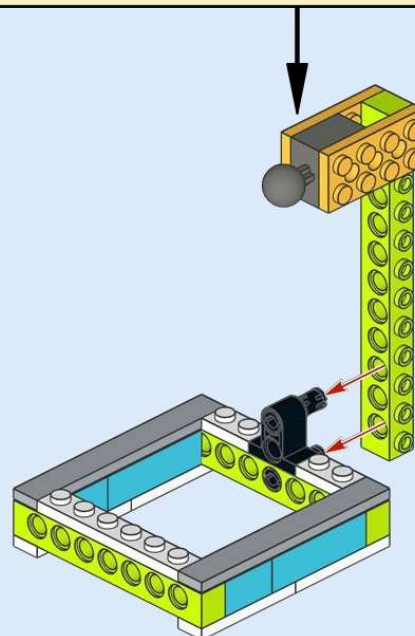
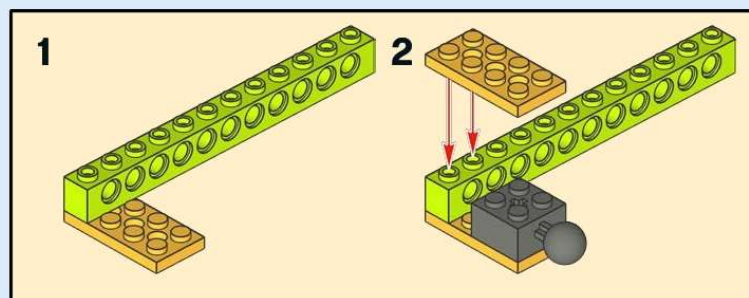
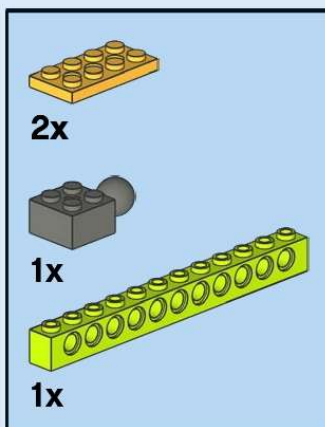

WEDO 2.0 «ЗАКОН ТЕНСЕГРИТИ»

7

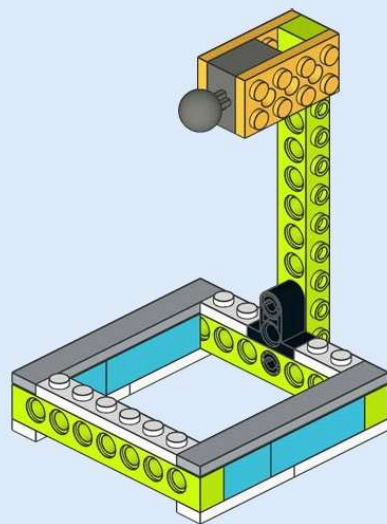

WEDO 2.0 «ЗАКОН ТЕНСЕГРИТИ»

8

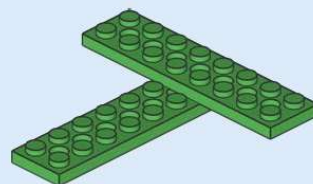
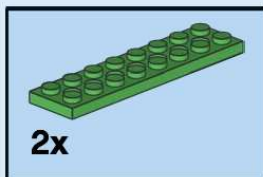

WEDO 2.0 «ЗАКОН ТЕНСЕГРИТИ»

9

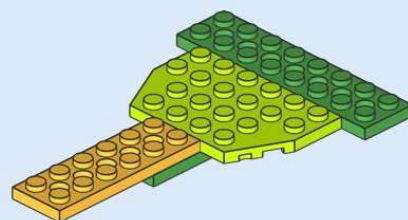
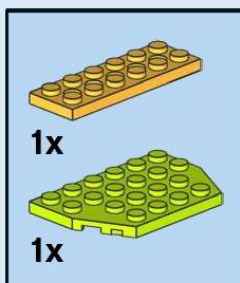

WEDO 2.0 «ЗАКОН ТЕНСЕГРИТИ»

10

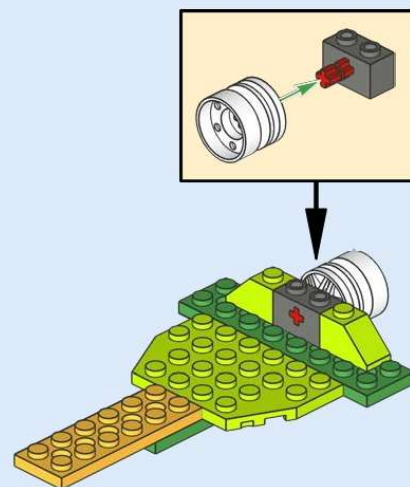

WEDO 2.0 «ЗАКОН ТЕНСЕГРИТИ»

11

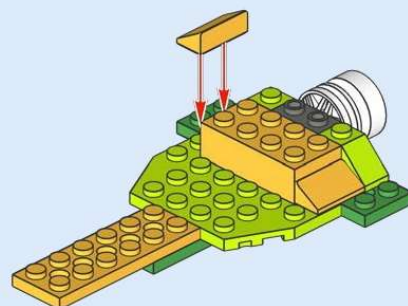
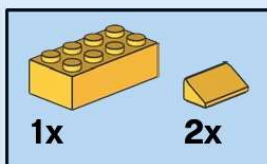

WEDO 2.0 «ЗАКОН ТЕНСЕГРИТИ»

12

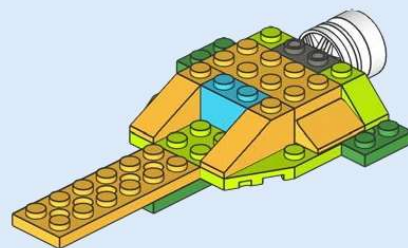
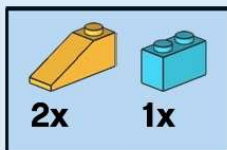

WEDO 2.0 «ЗАКОН ТЕНСЕГРИТИ»

13

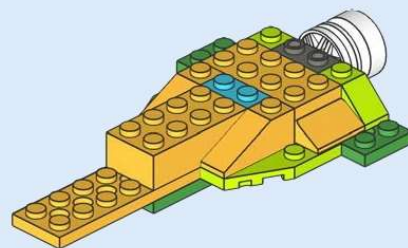
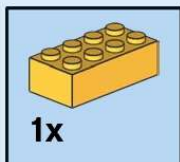

WEDO 2.0 «ЗАКОН ТЕНСЕГРИТИ»

14

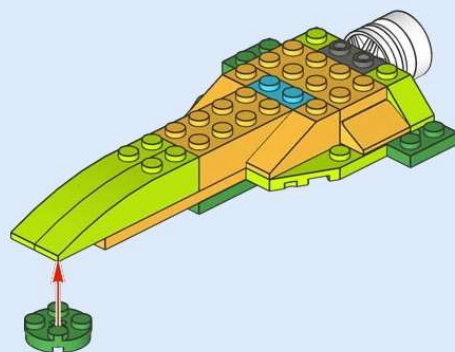
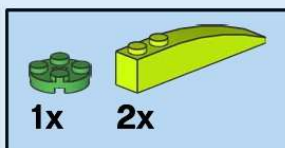

WEDO 2.0 «ЗАКОН ТЕНСЕГРИТИ»

15

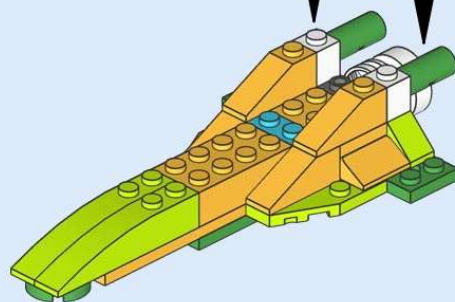
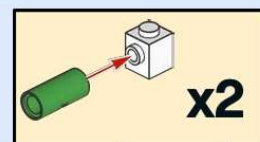
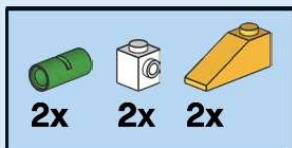

WEDO 2.0 «ЗАКОН ТЕНСЕГРИТИ»

16

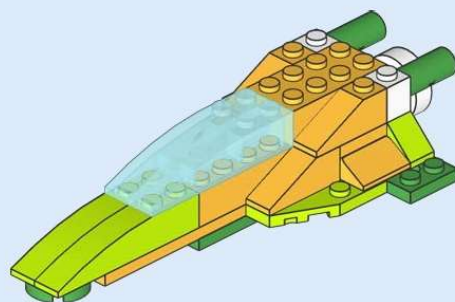
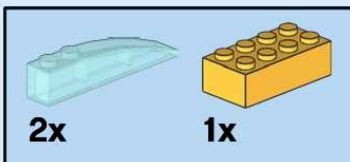

WEDO 2.0 «ЗАКОН ТЕНСЕГРИТИ»

17

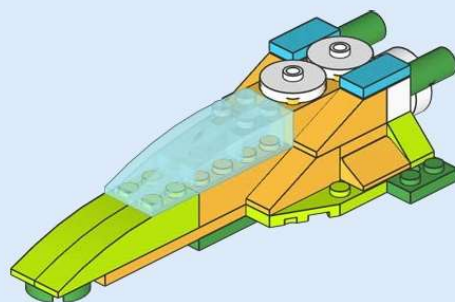
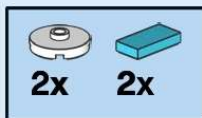

WEDO 2.0 «ЗАКОН ТЕНСЕГРИТИ»

18

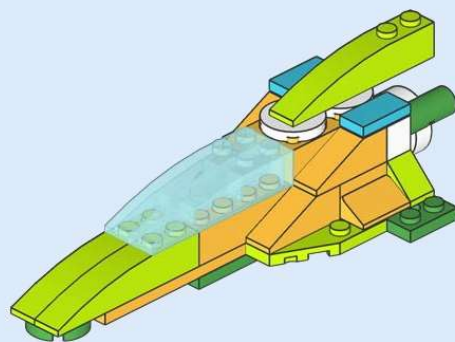
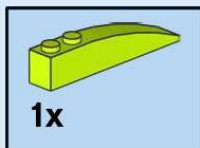

WEDO 2.0 «ЗАКОН ТЕНСЕГРИТИ»

19

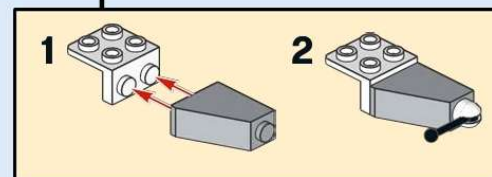
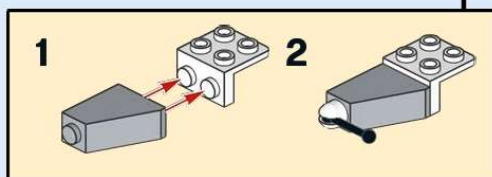
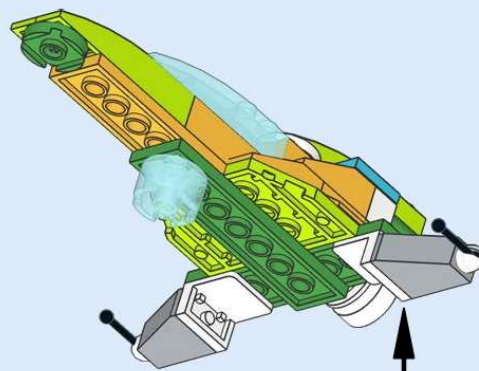
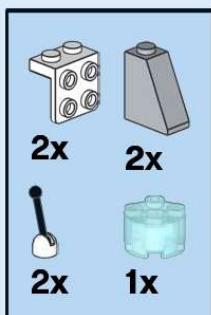

WEDO 2.0 «ЗАКОН ТЕНСЕГРИТИ»

20

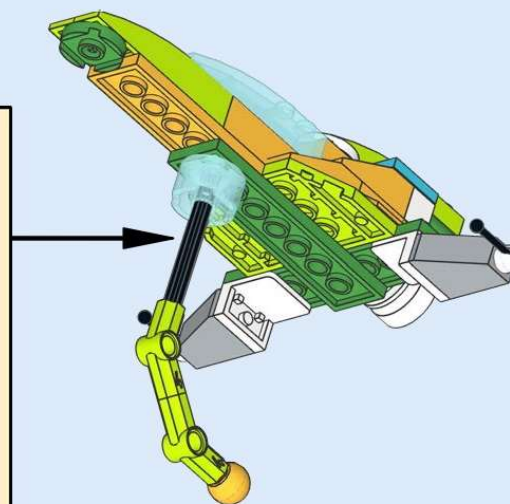
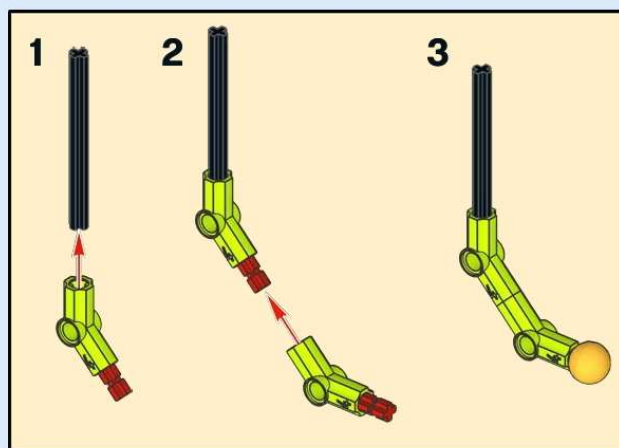
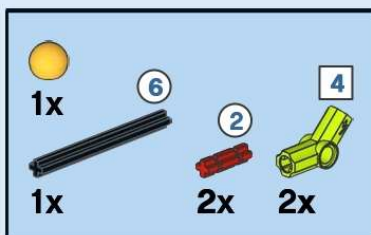

WEDO 2.0 «ЗАКОН ТЕНСЕГРИТИ»

21

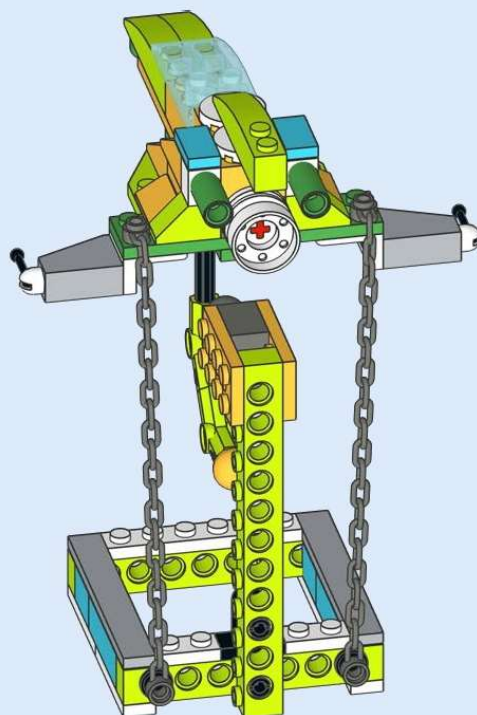

WEDO 2.0 «ЗАКОН ТЕНСЕГРИТИ»

22

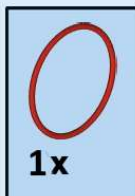

Для правильной балансировки космического корабля нужно отрегулировать черную ось, путем ее передвижения вверх или вниз.

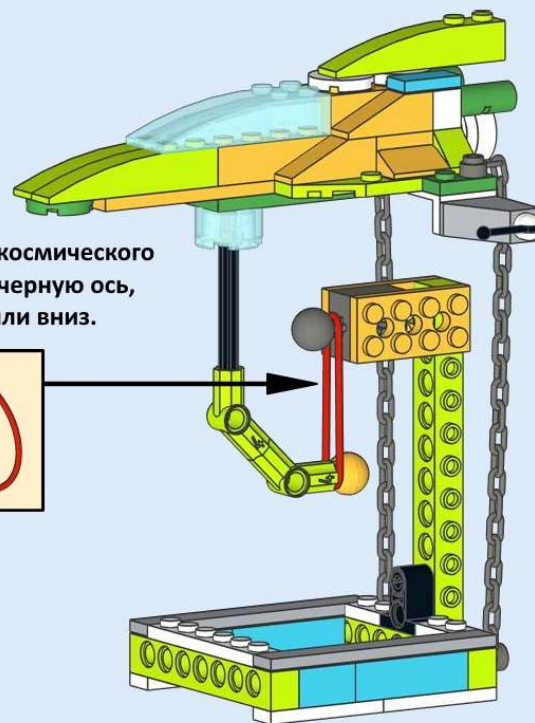
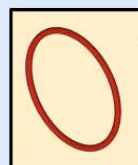

WEDO 2.0 «ЗАКОН ТЕНСЕГРИТИ»

ЗАДАНИЯ:

- 1) Объясните своими словами закон Тенсегрити.
 - 2) Видели ли вы работу этого закона в жизни?
- 

WEDO 2.0 «ЗАКОН ТЕНСЕГРИТИ»

Спасибо за
работу!!

